



# AFM60E-THAK002048

AFS/AFM60 SSI

**ABSOLUTE ENCODERS**

**SICK**  
Sensor Intelligence.

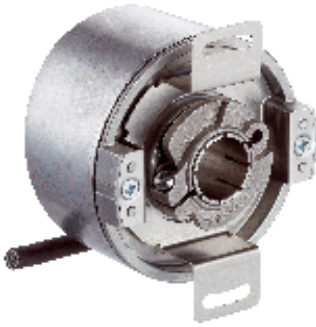

### Ordering information

| Type              | part no. |
|-------------------|----------|
| AFM60E-THAK002048 | 1054193  |

Other models and accessories → [www.sick.com/AFS\\_AFM60\\_SSI](http://www.sick.com/AFS_AFM60_SSI)

Illustration may differ

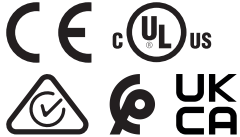

### Detailed technical data

#### Safety-related parameters

|  |  |
|--|--|
| <b>MTTF<sub>D</sub> (mean time to dangerous failure)</b> | 250 years (EN ISO 13849-1) <sup>1)</sup> |
|--|--|

<sup>1)</sup> This product is a standard product and does not constitute a safety component as defined in the Machinery Directive. Calculation based on nominal load of components, average ambient temperature 40 °C, frequency of use 8760 h/a. All electronic failures are considered hazardous. For more information, see document no. 8015532.

#### Performance

|   |                                 |
|---|---------------------------------|
| <b>Number of steps per revolution (max. resolution)</b>                         | 2,048 (11 bit)                  |
| <b>Number of revolutions</b>  | 4,096 (12 bit)                  |
| <b>Max. resolution (number of steps per revolution x number of revolutions)</b> | 11 bit x 12 bit (2,048 x 4,096) |
| <b>Error limits G</b>   | 0.2° <sup>1)</sup>              |
| <b>Repeatability standard deviation <math>\sigma_r</math></b>                   | 0.002° <sup>2)</sup>            |

<sup>1)</sup> In accordance with DIN ISO 1319-1, position of the upper and lower error limit depends on the installation situation, specified value refers to a symmetrical position, i.e. deviation in upper and lower direction is the same.

<sup>2)</sup> In accordance with DIN ISO 55350-13; 68.3% of the measured values are inside the specified area.

#### Interfaces

|   |  |
|---|--|
| <b>Communication interface</b>            | SSI  |
| <b>Initialization time</b>                | 50 ms <sup>1)</sup>                                |
| <b>Position forming time</b>              | < 1 $\mu$ s  |
| <b>Code type</b>                          | Gray   |
| <b>Code sequence parameter adjustable</b> | CW/CCW (V/R) parameter adjustable                  |
| <b>Clock frequency</b>                    | $\leq$ 1 MHz <sup>2)</sup>                         |
| <b>Set (electronic adjustment)</b>        | H-active (L = 0 - 3 V, H = 4,0 - U <sub>s</sub> V) |

<sup>1)</sup> Valid positional data can be read once this time has elapsed.

<sup>2)</sup> Minimum, LOW level (Clock +): 250 ns.

|  |  |
|--|--|
| <b>CW/CCW (counting sequence when turning)</b> | L-active (L = 0 - 1,5 V, H = 2,0 - Us V) |
|--|--|

<sup>1)</sup> Valid positional data can be read once this time has elapsed.

<sup>2)</sup> Minimum, LOW level (Clock +): 250 ns.

## Electronics

|                                    |   |
|------------------------------------|---|
| <b>Connection type</b>             | Cable, 8-wire, universal, 1.5 m <sup>1)</sup> |
| <b>Supply voltage</b>              | 4.5 ... 32 V                                  |
| <b>Power consumption</b>           | ≤ 0.7 W (without load)                        |
| <b>Reverse polarity protection</b> | ✓   |

<sup>1)</sup> The universal cable connection is positioned so that it is possible to lay it without bends in a radial or axial direction.

## Mechanics

|                                       |   |
|---------------------------------------|---|
| <b>Mechanical design</b>              | Through hollow shaft                    |
| <b>Shaft diameter</b>                 | 15 mm                                   |
| <b>Characteristics of the shaft</b>   | Front clamp                             |
| <b>Weight</b>                         | 0.2 kg <sup>1)</sup>                    |
| <b>Shaft material</b>                 | Stainless steel                         |
| <b>Flange material</b>                | Aluminum                                |
| <b>Housing material</b>               | Aluminum die cast                       |
| <b>Start up torque</b>                | < 0.8 Ncm (+20 °C)                      |
| <b>Operating torque</b>               | < 0.6 Ncm (+20 °C)                      |
| <b>Permissible movement static</b>    | ± 0.3 mm (radial)<br>± 0.5 mm (axial)   |
| <b>Permissible movement dynamic</b>   | ± 0.1 mm (radial)<br>± 0.2 mm (axial)   |
| <b>Operating speed</b>                | ≤ 9,000 min <sup>-1</sup> <sup>2)</sup> |
| <b>Moment of inertia of the rotor</b> | 40 gcm <sup>2</sup>                     |
| <b>Bearing lifetime</b>               | 3.0 x 10 <sup>9</sup> revolutions       |
| <b>Angular acceleration</b>           | ≤ 500,000 rad/s <sup>2</sup>            |

<sup>1)</sup> Based on devices with male connector.

<sup>2)</sup> Allow for self-heating of 3.3 K per 1,000 rpm when designing the operating temperature range.

## Ambient data

|                                      |  |
|--------------------------------------|--|
| <b>EMC</b>                           | According to EN 61000-6-2 and EN 61000-6-3 <sup>1)</sup>                     |
| <b>Enclosure rating</b>              | IP65, shaft side (IEC 60529)<br>IP67, housing side (IEC 60529) <sup>2)</sup> |
| <b>Permissible relative humidity</b> | 90 % (Condensation not permitted)  |
| <b>Operating temperature range</b>   | 0 °C ... +85 °C  |
| <b>Storage temperature range</b>     | -40 °C ... +100 °C, without package  |
| <b>Resistance to shocks</b>          | 50 g, 6 ms (EN 60068-2-27)   |
| <b>Resistance to vibration</b>       | 20 g, 10 Hz ... 2,000 Hz (EN 60068-2-6)                                      |

<sup>1)</sup> EMC according to the standards quoted is achieved if shielded cables are used.

<sup>2)</sup> For devices with male connector: with mounted mating connector.

### Certificates

|  |   |
|--|---|
| <b>EU declaration of conformity</b>  | ✓ |
| <b>UK declaration of conformity</b>  | ✓ |
| <b>ACMA declaration of conformity</b>  | ✓ |
| <b>Moroccan declaration of conformity</b>                                    | ✓ |
| <b>China-RoHS</b>  | ✓ |
| <b>cULus certificate</b>   | ✓ |
| <b>Information according to Art. 3 of Data Act (Regulation EU 2023/2854)</b> | ✓ |

### Classifications

|                       |          |
|-----------------------|----------|
| <b>ECLASS 5.0</b>     | 27270502 |
| <b>ECLASS 5.1.4</b>   | 27270502 |
| <b>ECLASS 6.0</b>     | 27270590 |
| <b>ECLASS 6.2</b>     | 27270590 |
| <b>ECLASS 7.0</b>     | 27270502 |
| <b>ECLASS 8.0</b>     | 27270502 |
| <b>ECLASS 8.1</b>     | 27270502 |
| <b>ECLASS 9.0</b>     | 27270502 |
| <b>ECLASS 10.0</b>    | 27270502 |
| <b>ECLASS 11.0</b>    | 27270502 |
| <b>ECLASS 12.0</b>    | 27270502 |
| <b>ETIM 5.0</b>       | EC001486 |
| <b>ETIM 6.0</b>       | EC001486 |
| <b>ETIM 7.0</b>       | EC001486 |
| <b>ETIM 8.0</b>       | EC001486 |
| <b>UNSPSC 16.0901</b> | 41112113 |

### Dimensional drawing

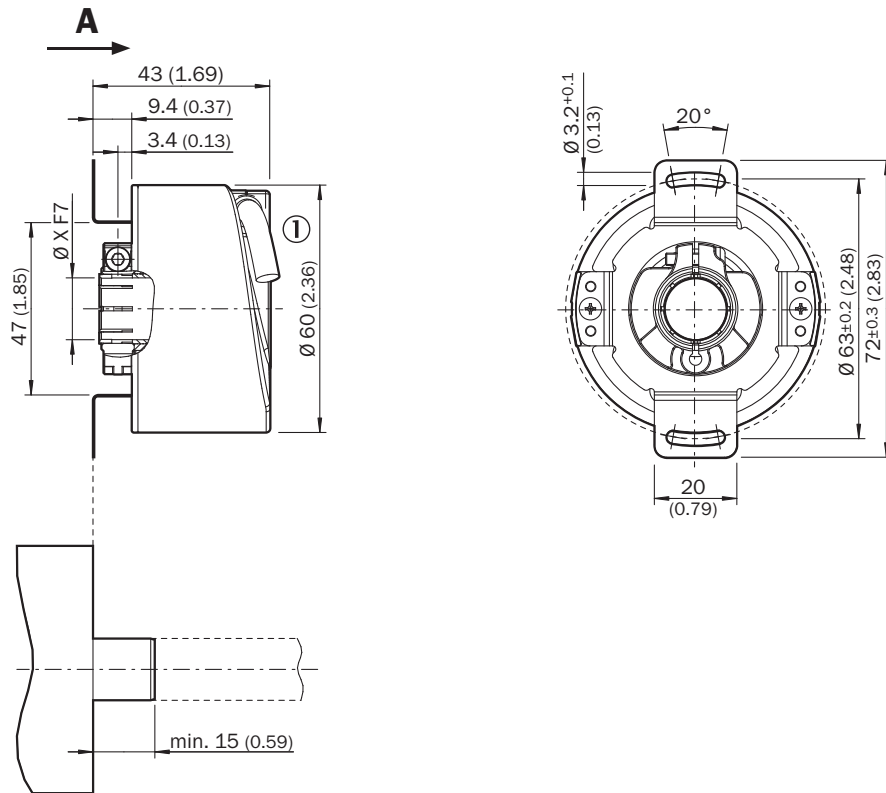

Dimensions in mm (inch)

① cable diameter = 5.6 mm +/- 0.2 mm bend radius = 30 mm

### PIN assignment

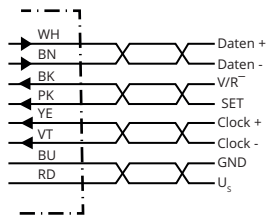

| PIN | Wire colors (cable connection) | Signal         | Explanation                             |
|-----|--------------------------------|----------------|---|
| 1   | Brown                          | Data -         | Interface signals                       |
| 2   | White                          | Data +         | Interface signals                       |
| 3   | Black                          | V/R            | Sequence in direction of rotation       |
| 4   | Pink                           | SET            | Electronic adjustment-Interface signals |
| 5   | Yellow                         | Clock +        | Interface signals                       |
| 6   | Purple                         | Clock -        | Interface signals                       |
| 7   | Blue                           | GND            | Ground connection                       |
| 8   | Red                            | U <sub>s</sub> | Operating voltage                       |

| PIN | Wire colors (cable connection) | Signal | Explanation   |
|-----|--------------------------------|--------|---|
| -   | -                              | Screen | Screen connected to housing on encoder side. Connected to ground on control side. |



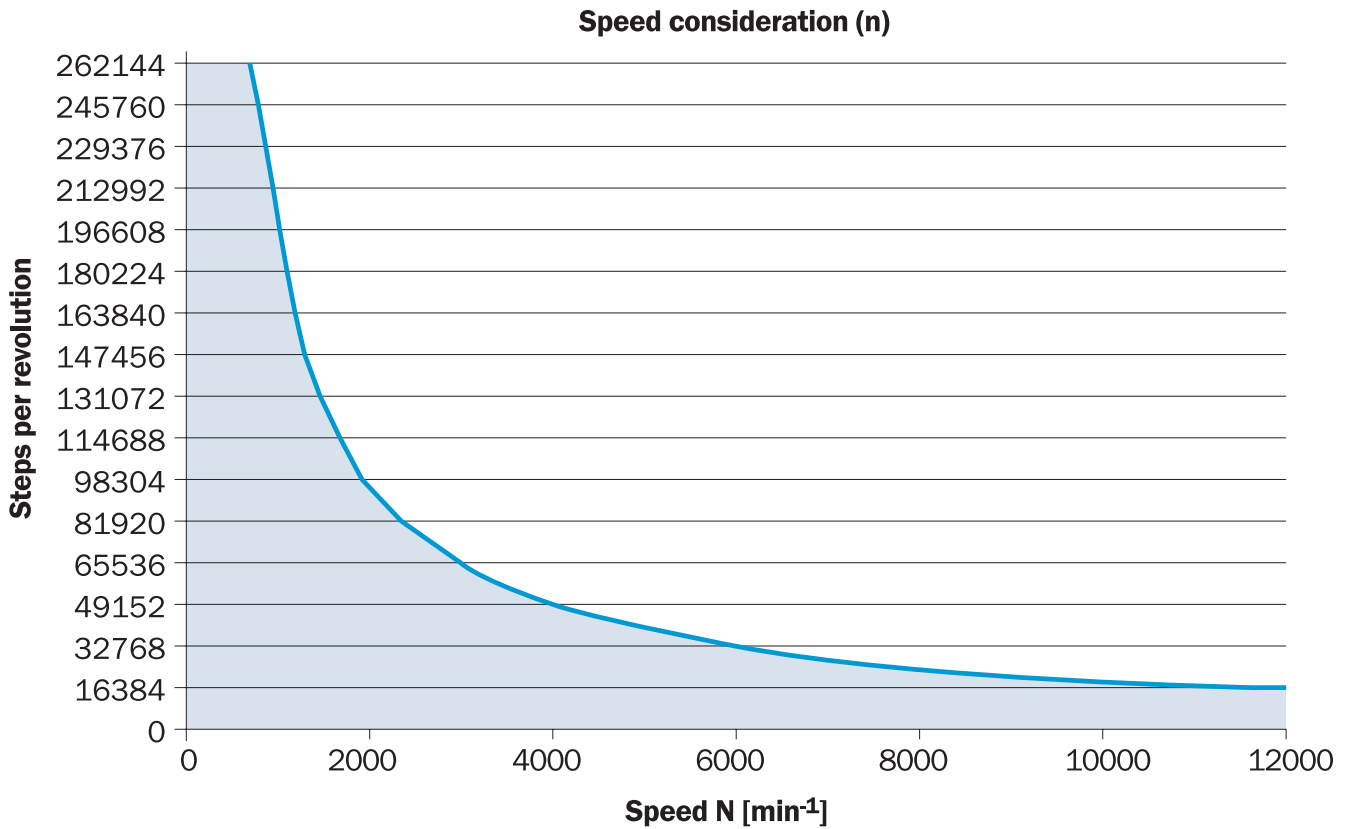

Diagrams



The maximum speed is also dependent on the shaft type.

## Recommended accessories

Other models and accessories → [www.sick.com/AFS\\_AFM60\\_SSI](http://www.sick.com/AFS_AFM60_SSI)

|   | Brief description   | Type          | part no. |
|---|---|---------------|----------|
| connectors and cables   |   |               |          |
|  | <ul style="list-style-type: none"> <li>• <b>Connection type head A:</b> Male connector, M23, 12-pin, straight, A-coded</li> <li>• <b>Signal type:</b> HIPERFACE<sup>®</sup>, SSI, Incremental, RS-422</li> <li>• <b>Description:</b> HIPERFACE<sup>®</sup>, shieldedSSIIncrementalRS-422</li> <li>• <b>Connection systems:</b> Solder connection</li> </ul>   | STE-2312-G    | 6027537  |
|  | <ul style="list-style-type: none"> <li>• <b>Connection type head A:</b> Male connector, M23, 12-pin, straight, A-coded</li> <li>• <b>Signal type:</b> HIPERFACE<sup>®</sup>, SSI, Incremental</li> <li>• <b>Description:</b> HIPERFACE<sup>®</sup>, shieldedSSIIncremental</li> <li>• <b>Connection systems:</b> Solder connection</li> </ul>   | STE-2312-GX   | 6028548  |
|  | <ul style="list-style-type: none"> <li>• <b>Connection type head A:</b> Male connector, M23, 12-pin, straight, A-coded</li> <li>• <b>Signal type:</b> HIPERFACE<sup>®</sup>, SSI, Incremental</li> <li>• <b>Description:</b> HIPERFACE<sup>®</sup>, shieldedSSIIncremental</li> <li>• <b>Connection systems:</b> Solder connection</li> </ul>   | STE-2312-G01  | 2077273  |
|  | <ul style="list-style-type: none"> <li>• <b>Connection type head A:</b> Male connector, M12, 8-pin, straight, A-coded</li> <li>• <b>Signal type:</b> Incremental</li> <li>• <b>Cable:</b> CAT5, CAT5e</li> <li>• <b>Description:</b> Incremental, shielded</li> <li>• <b>Connection systems:</b> IDC quick connection</li> <li>• <b>Permitted cross-section:</b> 0.14 mm<sup>2</sup> ... 0.34 mm<sup>2</sup></li> </ul> | STE-1208-GA01 | 6044892  |

## SICK AT A GLANCE

SICK is one of the leading manufacturers of intelligent sensors and sensor solutions for industrial applications. A unique range of products and services creates the perfect basis for controlling processes securely and efficiently, protecting individuals from accidents and preventing damage to the environment.

We have extensive experience in a wide range of industries and understand their processes and requirements. With intelligent sensors, we can deliver exactly what our customers need. In application centers in Europe, Asia and North America, system solutions are tested and optimized in accordance with customer specifications. All this makes us a reliable supplier and development partner.

Comprehensive services complete our offering: SICK LifeTime Services provide support throughout the machine life cycle and ensure safety and productivity.

For us, that is “Sensor Intelligence.”

## WORLDWIDE PRESENCE:

Contacts and other locations –[www.sick.com](http://www.sick.com)