

AFS60A-BKNB262144

AFS/AFM60 Ethernet

ABSOLUTE ENCODERS

SICK
Sensor Intelligence.



Ordering information

Type	part no.
AFS60A-BKNB262144	1059041

Other models and accessories → www.sick.com/AFS_AFM60_Ethernet

Illustration may differ



Detailed technical data

Safety-related parameters

MTTF_D (mean time to dangerous failure)	80 years (EN ISO 13849-1) ¹⁾
--	---

¹⁾ This product is a standard product and does not constitute a safety component as defined in the Machinery Directive. Calculation based on nominal load of components, average ambient temperature 40 °C, frequency of use 8760 h/a. All electronic failures are considered hazardous. For more information, see document no. 8015532.

Performance

Number of steps per revolution (max. resolution)	262,144 (18 bit)
Error limits G	0.03° ¹⁾
Repeatability standard deviation σ_r	0.002° ²⁾

¹⁾ In accordance with DIN ISO 1319-1, position of the upper and lower error limit depends on the installation situation, specified value refers to a symmetrical position, i.e. deviation in upper and lower direction is the same.

²⁾ In accordance with DIN ISO 55350-13; 68.3% of the measured values are inside the specified area.

Interfaces

Communication interface	PROFINET
Encoder profile	V4.1 class3
Data transmission rate (baud rate)	10 Mbit/s, 100 Mbit/s
Transmission medium	CAT-5e cable
Initialization time	6 s
Cycle time	≤ 1 ms
Parameterising data	Number of steps per revolution PRESET Counting direction Sampling rate for speed calculation Unit for output of the speed value
Available diagnostics data	Minimum and maximum temperature Maximum speed Power-on counter Operating hours counter power-on/motion Counter of direction changes/number of movements cw/number of movements ccw Maximum supply voltage

Electronics

Connection type	Male connector, 1x, M12, 4-pin, axial ¹⁾ Female connector, 2x, M12, 4-pin, axial ²⁾
Supply voltage	10 ... 30 V
Power consumption	≤ 3 W (without load)
Reverse polarity protection	✓

¹⁾ A-coded.

²⁾ D-coded.

Mechanics

Mechanical design	Blind hollow shaft
Shaft diameter	1/4"
Characteristics of the shaft	Front clamp
Weight	0.2 kg
Shaft material	Stainless steel
Flange material	Zinc diecast
Housing material	Aluminum
Start up torque	0.8 Ncm (+20 °C)
Operating torque	0.6 Ncm (+20 °C)
Permissible movement static	± 0.3 mm (radial) ± 0.5 mm (axial)
Permissible movement dynamic	± 0.05 mm (radial) ± 0.1 mm (axial)
Operating speed	≤ 6,000 min ⁻¹ ¹⁾
Moment of inertia of the rotor	40 gcm ²
Bearing lifetime	3 x 10 ⁹ revolutions
Angular acceleration	≤ 500,000 rad/s ²

¹⁾ Allow for self-heating of 3.3 K per 1,000 rpm when designing the operating temperature range.

Ambient data

EMC	According to EN 61000-6-2 and EN 61000-6-3
Enclosure rating	IP65, shaft side (IEC 60529) IP67, housing side (IEC 60529) ¹⁾
Permissible relative humidity	90 % (Condensation not permitted)
Operating temperature range	-40 °C ... +85 °C
Storage temperature range	-40 °C ... +100 °C, without package
Resistance to shocks	100 g, 6 ms (EN 60068-2-27)
Resistance to vibration	30 g, 10 Hz ... 2,000 Hz (EN 60068-2-6)

¹⁾ With mating connector fitted.

Certificates

EU declaration of conformity	✓
UK declaration of conformity	✓
ACMA declaration of conformity	✓

Moroccan declaration of conformity	✓
China-RoHS	✓
cTUVus certificate	✓
Profinet certificate	✓
Information according to Art. 3 of Data Act (Regulation EU 2023/2854)	✓

Classifications

ECLASS 5.0	27270502
ECLASS 5.1.4	27270502
ECLASS 6.0	27270590
ECLASS 6.2	27270590
ECLASS 7.0	27270502
ECLASS 8.0	27270502
ECLASS 8.1	27270502
ECLASS 9.0	27270502
ECLASS 10.0	27270502
ECLASS 11.0	27270502
ECLASS 12.0	27270502
ETIM 5.0	EC001486
ETIM 6.0	EC001486
ETIM 7.0	EC001486
ETIM 8.0	EC001486
UNSPSC 16.0901	41112113

Dimensional drawing Blind hollow shaft

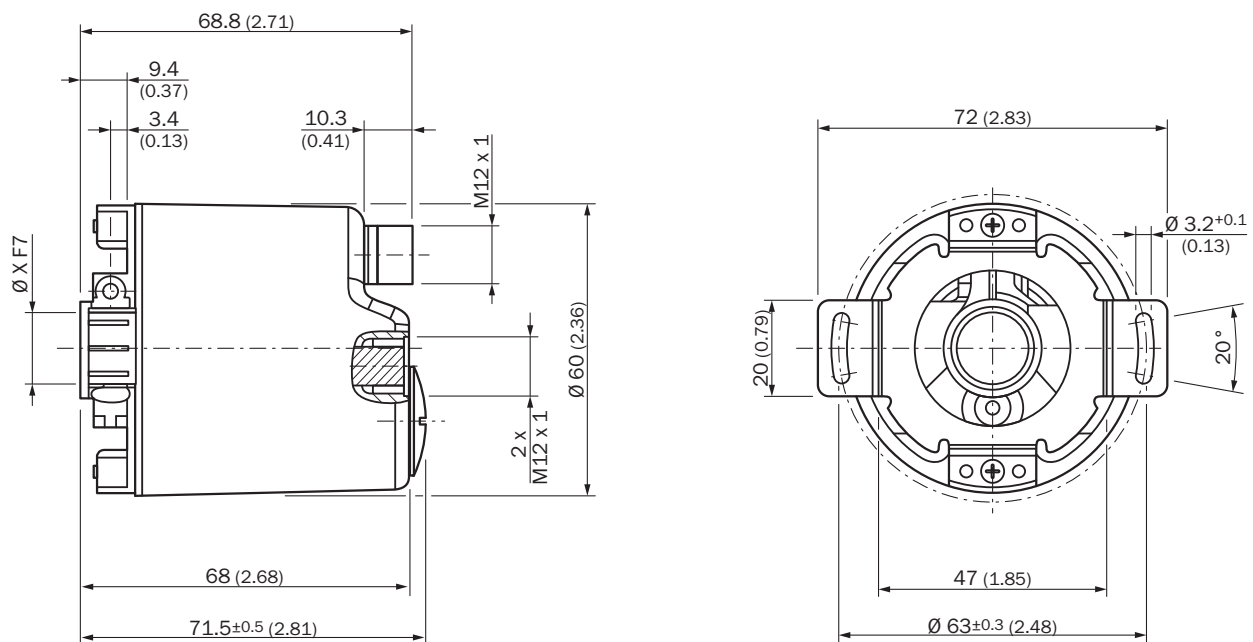

Dimensions in mm (inch)
diameter x f7 corresponds to the shaft diameter

Attachment specifications Blind hollow shaft

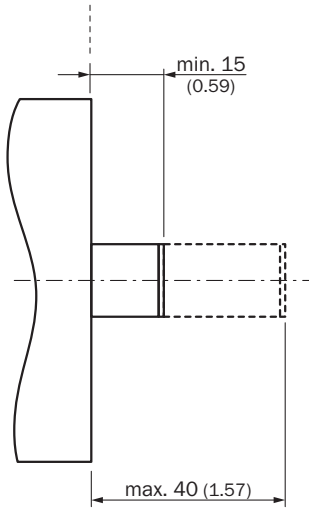

All dimensions in mm (inch)

PIN assignment Male connector

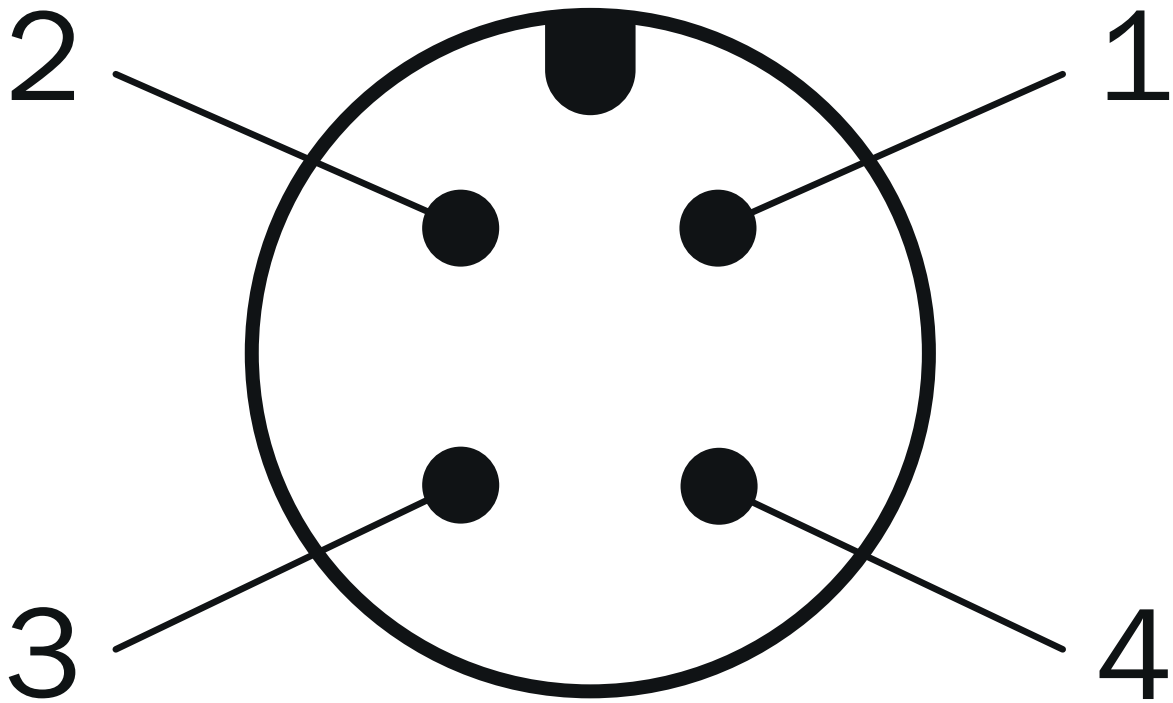

Supply voltage

PIN	Wire color	Signal
1	Brown	U _S 10 V ... 30 V
2	White	Not assigned
3	Blue	GND
4	Black	Not assigned

PIN assignment Female connector

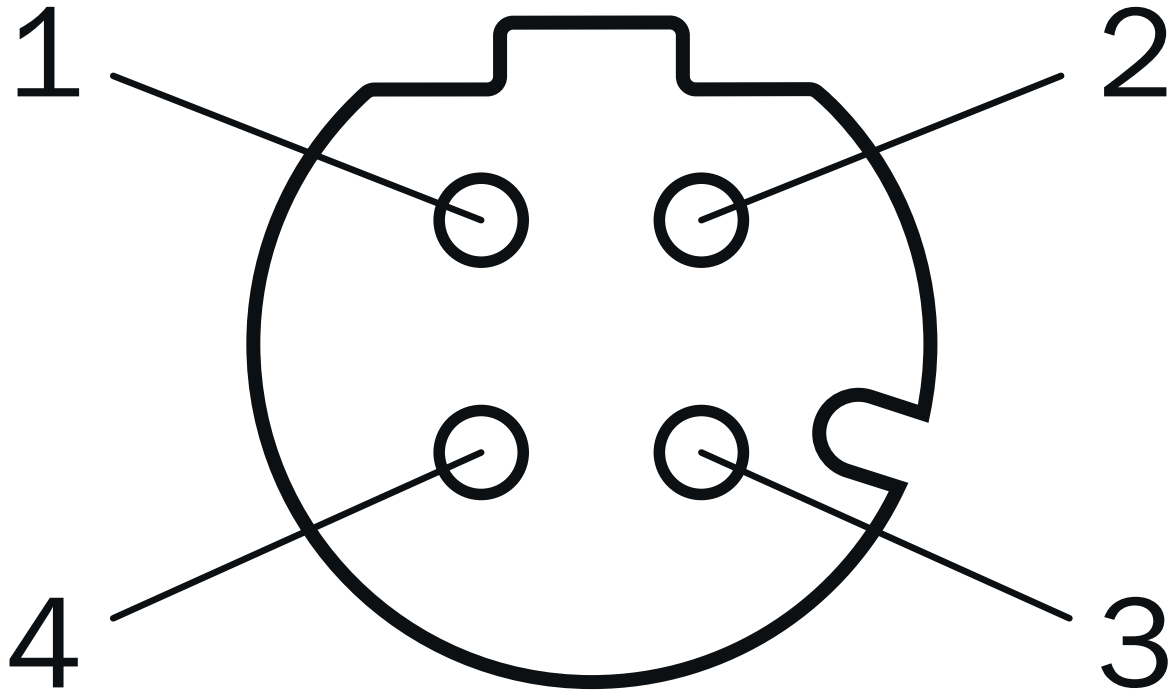

Port 1, Port 2

PIN	Wire color	Signal
1	Yellow	T x D+
2	White	R x D+
3	Orange	T x D-
4	Blue	R x D-

Connection diagram

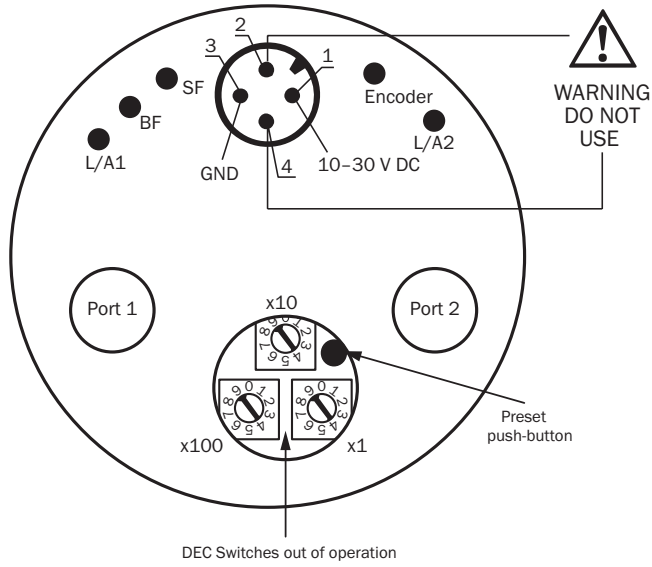









Recommended accessories









Other models and accessories → www.sick.com/AFS_AFM60_Ethernet

	Brief description	Type	part no.
connectors and cables			
	<ul style="list-style-type: none"> Connection type head A: Female connector, M12, 4-pin, angled, A-coded Description: Unshielded Connection systems: Screw-type terminals Permitted cross-section: ≤ 0.75 mm² 	DOS-1204-W	6007303
	<ul style="list-style-type: none"> Connection type head A: Female connector, M12, 4-pin, D-coded Connection type head B: Female connector, RJ45, 8-pin Signal type: Ethernet Cable: CAT5, CAT5e Description: Ethernet, shielded Note: Cabinet through 	Feedthrough female connector Ethernet RJ45	6048180
	<ul style="list-style-type: none"> Connection type head A: Male connector, RJ45, 4-pin, straight Connection type head B: Male connector, M12, 4-pin, angled, D-coded Signal type: Ethernet, PROFINET Cable: 30 m, 4-wire, CAT5, CAT5e, PVC Description: Ethernet, shieldedPROFINET 	SSL-2J04-F30MZ	6059450
	<ul style="list-style-type: none"> Connection type head A: Male connector, M12, 4-pin, angled, D-coded Signal type: PROFINET Cable: CAT5, CAT5e Description: PROFINET, shielded Connection systems: IDC quick connection Permitted cross-section: 0.14 mm² ... 0.34 mm² 	STE-1204-WZ	6048262
	<ul style="list-style-type: none"> Connection type head A: Female connector, M12, 4-pin, straight, A-coded Connection type head B: Flying leads Signal type: Sensor/actuator cable Cable: 2 m, 4-wire, PUR, halogen-free Description: Sensor/actuator cable, unshielded Application: Uncontaminated zones, Zones with oils and lubricants, Robot, Drag chain operation 	YF2A14-020UB3XLEAX	2095607
	<ul style="list-style-type: none"> Connection type head A: Female connector, M12, 4-pin, straight, A-coded Connection type head B: Flying leads Signal type: Sensor/actuator cable Cable: 5 m, 4-wire, PUR, halogen-free Description: Sensor/actuator cable, unshielded Application: Uncontaminated zones, Zones with oils and lubricants, Robot, Drag chain operation 	YF2A14-050UB3XLEAX	2095608
	<ul style="list-style-type: none"> Connection type head A: Female connector, M12, 4-pin, straight, A-coded Connection type head B: Flying leads Signal type: Sensor/actuator cable Cable: 10 m, 4-wire, PUR, halogen-free Description: Sensor/actuator cable, unshielded Application: Uncontaminated zones, Zones with oils and lubricants, Robot, Drag chain operation 	YF2A14-100UB3XLEAX	2095609
	<ul style="list-style-type: none"> Connection type head A: Female connector, M12, 4-pin, straight, A-coded Connection type head B: Flying leads Signal type: Sensor/actuator cable Cable: 25 m, 4-wire, PUR, halogen-free Description: Sensor/actuator cable, unshielded Application: Uncontaminated zones, Zones with oils and lubricants, Robot, Drag chain operation 	YF2A14-250UB3XLEAX	2095615
	<ul style="list-style-type: none"> Connection type head A: Female connector, M12, 4-pin, angled, A-coded Connection type head B: Flying leads Signal type: Sensor/actuator cable Cable: 2 m, 4-wire, PUR, halogen-free Description: Sensor/actuator cable, unshielded Application: Uncontaminated zones, Zones with oils and lubricants, Robot, Drag chain operation 	YG2A14-020UB3XLEAX	2095766
	<ul style="list-style-type: none"> Connection type head A: Female connector, M12, 4-pin, angled, A-coded Connection type head B: Flying leads Signal type: Sensor/actuator cable Cable: 5 m, 4-wire, PUR, halogen-free Description: Sensor/actuator cable, unshielded Application: Uncontaminated zones, Zones with oils and lubricants, Robot, Drag chain operation 	YG2A14-050UB3XLEAX	2095767
	<ul style="list-style-type: none"> Connection type head A: Female connector, M12, 4-pin, angled, A-coded Connection type head B: Flying leads Signal type: Sensor/actuator cable Cable: 10 m, 4-wire, PUR, halogen-free Description: Sensor/actuator cable, unshielded 	YG2A14-100UB3XLEAX	2095768

	Brief description	Type	part no.
	<ul style="list-style-type: none"> Application: Uncontaminated zones, Zones with oils and lubricants, Robot, Drag chain operation Connection type head A: Female connector, M12, 4-pin, angled, A-coded Connection type head B: Flying leads Signal type: Sensor/actuator cable Cable: 25 m, 4-wire, PUR, halogen-free Description: Sensor/actuator cable, unshielded Application: Uncontaminated zones, Zones with oils and lubricants, Robot, Drag chain operation 	YG2A14-250UB3XLEAX	2095771
	<ul style="list-style-type: none"> Connection type head A: Male connector, M12, 4-pin, angled, D-coded Connection type head B: Flying leads Signal type: Ethernet, PROFINET Cable: 25 m, 4-wire, PUR, halogen-free Description: Ethernet, shieldedPROFINET Application: Drag chain operation, Zones with oils and lubricants 	YN2D24-250P-N1XLEAX	2106180
	<ul style="list-style-type: none"> Connection type head A: Male connector, M12, 4-pin, angled, D-coded Connection type head B: Flying leads Signal type: Ethernet, PROFINET Cable: 10 m, 4-wire, PUR, halogen-free Description: Ethernet, shieldedPROFINET Application: Drag chain operation, Zones with oils and lubricants 	YN2D24-100P-N1XLEAX	2106176
	<ul style="list-style-type: none"> Connection type head A: Male connector, M12, 4-pin, angled, D-coded Connection type head B: Flying leads Signal type: Ethernet, PROFINET Cable: 5 m, 4-wire, PUR, halogen-free Description: Ethernet, shieldedPROFINET Application: Drag chain operation, Zones with oils and lubricants 	YN2D24-050P-N1XLEAX	2106175
	<ul style="list-style-type: none"> Connection type head A: Male connector, M12, 4-pin, straight, D-coded Connection type head B: Flying leads Signal type: Ethernet, PROFINET Cable: 10 m, 4-wire, PUR, halogen-free Description: Ethernet, shieldedPROFINET Application: Drag chain operation, Zones with oils and lubricants 	YM2D24-100P-N1XLEAX	2106173
	<ul style="list-style-type: none"> Connection type head A: Male connector, M12, 4-pin, straight, D-coded Connection type head B: Flying leads Signal type: Ethernet, PROFINET Cable: 5 m, 4-wire, PUR, halogen-free Description: Ethernet, shieldedPROFINET Application: Drag chain operation, Zones with oils and lubricants 	YM2D24-050P-N1XLEAX	2106172
	<ul style="list-style-type: none"> Connection type head A: Male connector, M12, 4-pin, straight, D-coded Connection type head B: Flying leads Signal type: Ethernet, PROFINET Cable: 2 m, 4-wire, PUR, halogen-free Description: Ethernet, shieldedPROFINET Application: Drag chain operation, Zones with oils and lubricants 	YM2D24-020P-N1XLEAX	2106171
	<ul style="list-style-type: none"> Connection type head A: Male connector, M12, 4-pin, angled, D-coded Connection type head B: Male connector, M12, 4-pin, angled, D-coded Signal type: Ethernet, PROFINET Cable: 10 m, 4-wire, PUR, halogen-free Description: Ethernet, shieldedPROFINET Application: Drag chain operation, Zones with oils and lubricants 	YN2D24-100P-N1N2D24	2106170
	<ul style="list-style-type: none"> Connection type head A: Male connector, M12, 4-pin, angled, D-coded Connection type head B: Male connector, M12, 4-pin, angled, D-coded Signal type: Ethernet, PROFINET Cable: 2 m, 4-wire, PUR, halogen-free Description: Ethernet, shieldedPROFINET Application: Drag chain operation, Zones with oils and lubricants 	YN2D24-020P-N1N2D24	2106168
	<ul style="list-style-type: none"> Connection type head A: Male connector, M12, 4-pin, straight, D-coded Connection type head B: Male connector, M12, 4-pin, straight, D-coded Signal type: Ethernet, PROFINET Cable: 10 m, 4-wire, PUR, halogen-free Description: Ethernet, shieldedPROFINET Application: Drag chain operation, Zones with oils and lubricants 	YM2D24-100P-N1M2D24	2106161
	<ul style="list-style-type: none"> Connection type head A: Male connector, M12, 4-pin, straight, D-coded Connection type head B: Male connector, M12, 4-pin, angled, D-coded Signal type: Ethernet, PROFINET Cable: 10 m, 4-wire, PUR, halogen-free Description: Ethernet, shieldedPROFINET 	YM2D24-100P-N1N2D24	2106167

	Brief description	Type	part no.
	<ul style="list-style-type: none"> Application: Drag chain operation, Zones with oils and lubricants Connection type head A: Male connector, M12, 4-pin, straight, D-coded Connection type head B: Male connector, M12, 4-pin, angled, D-coded Signal type: Ethernet, PROFINET Cable: 5 m, 4-wire, PUR, halogen-free Description: Ethernet, shieldedPROFINET Application: Drag chain operation, Zones with oils and lubricants 	YM2D24-050P-N1N2D24	2106166
	<ul style="list-style-type: none"> Connection type head A: Male connector, M12, 4-pin, straight, D-coded Connection type head B: Male connector, M12, 4-pin, angled, D-coded Signal type: Ethernet, PROFINET Cable: 2 m, 4-wire, PUR, halogen-free Description: Ethernet, shieldedPROFINET Application: Drag chain operation, Zones with oils and lubricants 	YM2D24-020P-N1N2D24	2106165
	<ul style="list-style-type: none"> Connection type head A: Male connector, M12, 4-pin, straight, D-coded Connection type head B: Male connector, RJ45, 4-pin, straight Signal type: Ethernet, PROFINET Cable: 2 m, 4-wire, PUR, halogen-free Description: Ethernet, shieldedPROFINET Application: Drag chain operation, Zones with oils and lubricants 	YM2D24-020P-N1MRJA4	2106182
	<ul style="list-style-type: none"> Connection type head A: Male connector, M12, 4-pin, straight, D-coded Connection type head B: Male connector, RJ45, 4-pin, straight Signal type: Ethernet, PROFINET Cable: 10 m, 4-wire, PUR, halogen-free Description: Ethernet, shieldedPROFINET Application: Drag chain operation, Zones with oils and lubricants 	YM2D24-100P-N1MRJA4	2106185
	<ul style="list-style-type: none"> Connection type head A: Male connector, M12, 4-pin, angled, D-coded Connection type head B: Male connector, RJ45, 4-pin, straight Signal type: Ethernet, PROFINET Cable: 10 m, 4-wire, PUR, halogen-free Description: Ethernet, shieldedPROFINET Application: Drag chain operation, Zones with oils and lubricants 	YN2D24-100P-N1MRJA4	2106164
	<ul style="list-style-type: none"> Connection type head A: Male connector, M12, 4-pin, angled, D-coded Connection type head B: Male connector, RJ45, 4-pin, straight Signal type: Ethernet, PROFINET Cable: 5 m, 4-wire, PUR, halogen-free Description: Ethernet, shieldedPROFINET Application: Drag chain operation, Zones with oils and lubricants 	YN2D24-050P-N1MRJA4	2106163
	<ul style="list-style-type: none"> Connection type head A: Male connector, M12, 4-pin, angled, D-coded Connection type head B: Male connector, RJ45, 4-pin, straight Signal type: Ethernet, PROFINET Cable: 2 m, 4-wire, PUR, halogen-free Description: Ethernet, shieldedPROFINET Application: Drag chain operation, Zones with oils and lubricants 	YN2D24-020P-N1MRJA4	2106162
	<ul style="list-style-type: none"> Connection type head A: Male connector, M12, 4-pin, straight, D-coded Connection type head B: Male connector, M12, 4-pin, straight, D-coded Signal type: Ethernet, PROFINET Cable: 5 m, 4-wire, PUR, halogen-free Description: Ethernet, shieldedPROFINET Application: Drag chain operation, Zones with oils and lubricants 	YM2D24-050P-N1M2D24	2106160
	<ul style="list-style-type: none"> Connection type head A: Male connector, M12, 4-pin, angled, D-coded Connection type head B: Male connector, RJ45, 4-pin, straight Signal type: Ethernet, PROFINET Cable: 3 m, 4-wire, PUR, halogen-free Description: Ethernet, shieldedPROFINET Application: Drag chain operation, Zones with oils and lubricants 	YN2D24-030P-N1MRJA4	2144265
	<ul style="list-style-type: none"> Connection type head A: Female connector, M12, 4-pin, straight, A-coded Connection type head B: Flying leads Signal type: Sensor/actuator cable Cable: 0.6 m, 4-wire, PUR, halogen-free Description: Sensor/actuator cable, unshielded Application: Uncontaminated zones, Zones with oils and lubricants, Robot, Drag chain operation 	YF2A14-C60UB3XLEAX	2145654
	<ul style="list-style-type: none"> Connection type head A: Female connector, M12, 4-pin, straight, A-coded Connection type head B: Flying leads Signal type: Sensor/actuator cable Cable: 1 m, 4-wire, PUR, halogen-free Description: Sensor/actuator cable, unshielded 	YF2A14-010UB3XLEAX	2145655

	Brief description	Type	part no.
	<ul style="list-style-type: none"> Application: Uncontaminated zones, Zones with oils and lubricants, Robot, Drag chain operation Connection type head A: Female connector, M12, 4-pin, straight, A-coded Connection type head B: Flying leads Signal type: Sensor/actuator cable Cable: 3 m, 4-wire, PUR, halogen-free Description: Sensor/actuator cable, unshielded Application: Uncontaminated zones, Zones with oils and lubricants, Robot, Drag chain operation 	YF2A14-030UB3XLEAX	2145656
	<ul style="list-style-type: none"> Connection type head A: Female connector, M12, 4-pin, angled, A-coded Connection type head B: Flying leads Signal type: Sensor/actuator cable Cable: 0.6 m, 4-wire, PUR, halogen-free Description: Sensor/actuator cable, unshielded Application: Uncontaminated zones, Zones with oils and lubricants, Robot, Drag chain operation 	YG2A14-C60UB3XLEAX	2145657
	<ul style="list-style-type: none"> Connection type head A: Female connector, M12, 4-pin, angled, A-coded Connection type head B: Flying leads Signal type: Sensor/actuator cable Cable: 1 m, 4-wire, PUR, halogen-free Description: Sensor/actuator cable, unshielded Application: Uncontaminated zones, Zones with oils and lubricants, Robot, Drag chain operation 	YG2A14-010UB3XLEAX	2145658
	<ul style="list-style-type: none"> Connection type head A: Male connector, M12, 4-pin, angled, D-coded Connection type head B: Male connector, M12, 4-pin, angled, D-coded Signal type: Ethernet, PROFINET Cable: 5 m, 4-wire, PUR, halogen-free Description: Ethernet, shieldedPROFINET Application: Drag chain operation, Zones with oils and lubricants 	YN2D24-050P-N1N2D24	2127662
	<ul style="list-style-type: none"> Connection type head A: Male connector, M12, 4-pin, angled, D-coded Connection type head B: Male connector, RJ45, 4-pin, straight Signal type: Ethernet, PROFINET Cable: 20 m, 4-wire, PUR, halogen-free Description: Ethernet, shieldedPROFINET Application: Drag chain operation, Zones with oils and lubricants 	YN2D24-200P-N1MRJA4	2127664
	<ul style="list-style-type: none"> Connection type head A: Male connector, M12, 4-pin, straight, D-coded Connection type head B: Male connector, RJ45, 4-pin, straight Signal type: Ethernet, PROFINET Cable: 5 m, 4-wire, PUR, halogen-free Description: Ethernet, shieldedPROFINET Application: Drag chain operation, Zones with oils and lubricants 	YM2D24-050P-N1MRJA4	2106184
	<ul style="list-style-type: none"> Connection type head A: Male connector, M12, 4-pin, angled, D-coded Connection type head B: Flying leads Signal type: Ethernet, PROFINET Cable: 20 m, 4-wire, PUR, halogen-free Description: Ethernet, shieldedPROFINET Application: Drag chain operation, Zones with oils and lubricants 	YN2D24-200P-N1XLEAX	2122743
	<ul style="list-style-type: none"> Connection type head A: Female connector, M12, 4-pin, angled, A-coded Connection type head B: Flying leads Signal type: Sensor/actuator cable Cable: 20 m, 4-wire, PUR, halogen-free Description: Sensor/actuator cable, unshielded Application: Uncontaminated zones, Zones with oils and lubricants, Robot, Drag chain operation 	YG2A14-200UB3XLEAX	2095770
	<ul style="list-style-type: none"> Connection type head A: Female connector, M12, 4-pin, straight, A-coded Connection type head B: Flying leads Signal type: Sensor/actuator cable Cable: 20 m, 4-wire, PUR, halogen-free Description: Sensor/actuator cable, unshielded Application: Uncontaminated zones, Zones with oils and lubricants, Robot, Drag chain operation 	YF2A14-200UB3XLEAX	2095611

	Brief description	Type	part no.
Mounting systems			
	<ul style="list-style-type: none"> Description: Flange adapter, adaptation of face mount flange with 36 mm centering hub to 50 mm servo flange, aluminum, including 3 flat head screws M4 x 10 Material: Aluminum Details: Aluminum Items supplied: Including 3 countersunk screws M3 x 10 	BEF-FA-036-050	2029160
	<ul style="list-style-type: none"> Description: Flange adapter, adaptation of face mount flange with 36 mm centering hub to 60 mm square mounting plate, aluminum, including 3 flat head screws M4 x 8 Material: Aluminum Details: Aluminum Items supplied: Including 3 countersunk screws M4 x 8 	BEF-FA-036-060REC	2029162
	<ul style="list-style-type: none"> Description: Flange adapter, adaptation of face mount flange with 36 mm centering hub to 58 mm square mounting plate with shock absorbers, aluminum Material: Aluminum Details: Aluminum 	BEF-FA-036-060RSA	2029163
	<ul style="list-style-type: none"> Description: Flange adapter, adaptation of face mount flange with 36 mm centering hub to 63 mm square mounting plate, aluminum, including 3 flat head screws M4 x 10 Material: Aluminum Details: Aluminum Items supplied: Including 3 countersunk screws M3 x 10 	BEF-FA-036-063REC	2034225
	<ul style="list-style-type: none"> Product family: Stator couplings Description: Standard stator coupling 	BEF-DS00XFX	2056812
	<ul style="list-style-type: none"> Product family: Stator couplings Description: One-sided stator coupling, slot, slot radius 33 mm to 211.9 mm, slot width 5.1 mm 	BEF-DS03DFS/VFS	2047431
	<ul style="list-style-type: none"> Product family: Stator couplings Description: Stator coupling with hole circle diameter Ø72 mm 	BEF-DS07XFX	2059368
	<ul style="list-style-type: none"> Description: Clamping ring for metal hollow shaft Material: Steel Details: Metal 	BEF-KR-M	2064709

	Brief description	Type	part no.
measuring wheels and measuring wheel mechanics			
	<ul style="list-style-type: none"> Product segment: Measuring wheels and measuring wheel mechanics Product family: Measuring wheels Description: Aluminium measuring wheel with O-ring (NBR70) for 6 mm solid shaft, circumference 200 mm 	BEF-MR006020R	2055222
	<ul style="list-style-type: none"> Product segment: Measuring wheels and measuring wheel mechanics Product family: Measuring wheels Description: Measuring wheel with O-ring (NBR70) for 6 mm solid shaft, circumference 300 mm 	BEF-MR006030R	2055634
	<ul style="list-style-type: none"> Product segment: Measuring wheels and measuring wheel mechanics Product family: Measuring wheels Description: Plastic measuring wheel with smooth plastic surface (Hytrel), for 10 mm solid shaft, circumference 200 mm 	BEF-MR-010020	5312988
	<ul style="list-style-type: none"> Product segment: Measuring wheels and measuring wheel mechanics Product family: Measuring wheels Description: Measuring wheel with ridged plastic surface (Hytrel) for 10 mm solid shaft, circumference 200 mm 	BEF-MR-010020G	5318678
	<ul style="list-style-type: none"> Product segment: Measuring wheels and measuring wheel mechanics Product family: Measuring wheels Description: Aluminium measuring wheel with O-ring (NBR70) for 10 mm solid shaft, circumference 200 mm 	BEF-MR010020R	2055224
	<ul style="list-style-type: none"> Product segment: Measuring wheels and measuring wheel mechanics Product family: Measuring wheels Description: Aluminium measuring wheel with O-ring (NBR70) for 10 mm solid shaft, circumference 300 mm 	BEF-MR010030R	2049278
	<ul style="list-style-type: none"> Product segment: Measuring wheels and measuring wheel mechanics Product family: Measuring wheels Description: Plastic measuring wheel with smooth plastic surface (Hytrel) for 10 mm solid shaft, circumference 500 mm 	BEF-MR-010050	5312989
	<ul style="list-style-type: none"> Product segment: Measuring wheels and measuring wheel mechanics Product family: Measuring wheels Description: Measuring wheel with O-ring (NBR70) for 10 mm solid shaft, circumference 500 mm 	BEF-MR010050R	2055227
	<ul style="list-style-type: none"> Product segment: Measuring wheels and measuring wheel mechanics 	BEF-OR-053-040	2064061

	Brief description	Type	part no.
	<ul style="list-style-type: none"> • Product family: Measuring wheel mechanics • Description: O-ring for measuring wheels (circumference 200 mm) 		
	<ul style="list-style-type: none"> • Product segment: Measuring wheels and measuring wheel mechanics • Product family: Measuring wheel mechanics • Description: O-ring for measuring wheels (circumference 300 mm) • Items supplied: 2x O-ring 	BEF-OR-083-050	2064076

SICK AT A GLANCE

SICK is one of the leading manufacturers of intelligent sensors and sensor solutions for industrial applications. A unique range of products and services creates the perfect basis for controlling processes securely and efficiently, protecting individuals from accidents and preventing damage to the environment.

We have extensive experience in a wide range of industries and understand their processes and requirements. With intelligent sensors, we can deliver exactly what our customers need. In application centers in Europe, Asia and North America, system solutions are tested and optimized in accordance with customer specifications. All this makes us a reliable supplier and development partner.

Comprehensive services complete our offering: SICK LifeTime Services provide support throughout the machine life cycle and ensure safety and productivity.

For us, that is “Sensor Intelligence.”

WORLDWIDE PRESENCE:

Contacts and other locations –www.sick.com