



# WTT4SLC-3B2262B01

WTT4 PowerProx

TIME-OF-FLIGHT SENSORS

**SICK**  
Sensor Intelligence.



Illustration may differ

### Ordering information

Type	part no.
WTT4SLC-3B2262B01	1106949

Other models and accessories → [www.sick.com/WTT4\\_PowerProx](http://www.sick.com/WTT4_PowerProx)



### Detailed technical data

#### Features

<b>Functional principle</b>	Photoelectric proximity sensor
<b>Functional principle detail</b>	Background suppression, Optical time-of-flight
<b>Housing design (light emission)</b>	Rectangular
<b>Sensing range max.</b>	50 mm ... 1,300 mm <sup>1)</sup>
<b>Sensing range</b>	100 mm ... 1,300 mm <sup>2)</sup>
<b>Distance value</b>	
Measuring range	90 mm ... 1,300 mm <sup>1)</sup>
Resolution	1 mm
Repeatability	4,5 mm ... 11 mm <sup>3) 4) 5)</sup>
Accuracy	± 35 mm
Distance value output	Via IO-Link
Update rate of the distance value	0.8 ms
<b>Type of light</b>	Visible red light
<b>Light source</b>	Laser <sup>6)</sup>
<b>Light spot size (distance)</b>	Ø 4.4 mm (1,300 mm)

<sup>1)</sup> Object with 6 ... 90% remission (based on standard white, DIN 5033).

<sup>2)</sup> Adjustable.

<sup>3)</sup> Equivalent to 1  $\sigma$ .

<sup>4)</sup> See characteristic curves repeatability.

<sup>5)</sup> 6% ... 90% remission factor.

<sup>6)</sup> Average service life: 50,000 h at  $T_U = +25 \text{ }^\circ\text{C}$ .

<b>Wave length</b>	658 nm
<b>Laser class</b>	1 (IEC 60825-1 / CDRH 21 CFR 1040.10 & 1040.11)
<b>Adjustment</b>	Single teach-in button, IO-Link
<b>Pin 2 configuration</b>	External input, Teach-in input, Sender off input, Detection output, logic output
<b>Safety-related parameters</b>	
	MTTF <sub>D</sub> 256 years
	DC <sub>avg</sub> 0 %
	T <sub>M</sub> (mission time) 20 years

1) Object with 6 ... 90% remission (based on standard white, DIN 5033).

2) Adjustable.

3) Equivalent to 1  $\sigma$ .

4) See characteristic curves repeatability.

5) 6% ... 90% remission factor.

6) Average service life: 50,000 h at T<sub>U</sub> = +25 °C.

## Interfaces

<b>Communication interface</b>	IO-Link V1.1
<b>Communication Interface detail</b>	COM3 (230,4 kBaud)
<b>Cycle time</b>	0.8 ms
<b>Process data length</b>	4 Byte
<b>Process data structure</b>	Bit 0 = switching signal Q <sub>L1</sub> Bit 1 = switching signal Q <sub>L2</sub> Bit 2 = detection signal Q <sub>int.1</sub> Bit 3 = detection signal Q <sub>int.2</sub> Bit 4 = detection signal Q <sub>int.3</sub> Bit 5 = detection signal Q <sub>int.4</sub> Bit 6 = detection signal Q <sub>int.5</sub> Bit 7 = detection signal Q <sub>int.6</sub> Bit 8 = detection signal Q <sub>int.7</sub> Bit 9 = detection signal Q <sub>int.8</sub> Bit 10 ... 15 = empty Bit 16 ... 31 = distance value
<b>VendorID</b>	26
<b>DeviceID HEX</b>	0x800264
<b>DeviceID DEC</b>	8389220

## Electronics

<b>Supply voltage U<sub>B</sub></b>	10 V DC ... 30 V DC <sup>1)</sup>
<b>Ripple</b>	< 5 V <sub>pp</sub> <sup>2)</sup>
<b>Current consumption</b>	25 mA <sup>3)</sup>
<b>Switching output</b>	Push-pull: PNP/NPN

1) Limit values. Operated in short-circuit protected network: max. 8 A.

2) May not fall below or exceed U<sub>y</sub> tolerances.

3) Without load.

4) Signal transit time with resistive load.

5) With light/dark ratio 1:1.

6) A = V<sub>S</sub> connections reverse-polarity protected.

7) B = output reverse-polarity protected.

8) D = outputs overcurrent and short-circuit protected.

9) Below T<sub>U</sub> = -10 °C a warm-up time is necessary.

<b>Output function</b>	Factory setting: Pin 2 / white (MF): test input, Pin 4 / black: NPN normally closed (light switching), PNP normally open (dark switching)
<b>Switching mode</b>	Light/dark switching
<b>Output current <math>I_{\max}</math></b>	$\leq 50$ mA
<b>Response time</b>	$\leq 5$ ms <sup>4)</sup>
<b>Switching frequency</b>	100 Hz <sup>5)</sup>
<b>Input</b>	MF <sub>in</sub> = multifunctional input programmable
<b>Circuit protection</b>	A <sup>6)</sup> B <sup>7)</sup> D <sup>8)</sup>
<b>Protection class</b>	III
<b>Enclosure rating</b>	IP67
<b>Warm-up time</b>	< 10 min <sup>9)</sup>
<b>Initialization time</b>	< 300 ms

<sup>1)</sup> Limit values. Operated in short-circuit protected network: max. 8 A.

<sup>2)</sup> May not fall below or exceed  $U_V$  tolerances.

<sup>3)</sup> Without load.

<sup>4)</sup> Signal transit time with resistive load.

<sup>5)</sup> With light/dark ratio 1:1.

<sup>6)</sup> A =  $V_S$  connections reverse-polarity protected.

<sup>7)</sup> B = output reverse-polarity protected.

<sup>8)</sup> D = outputs overcurrent and short-circuit protected.

<sup>9)</sup> Below  $T_u = -10$  °C a warm-up time is necessary.

### Mechanics

<b>Dimensions (W x H x D)</b>	12.2 mm x 41.8 mm x 17.3 mm
<b>Housing material</b>	Plastic, MABS, ABS
<b>Optics material</b>	Plastic, PMMA
<b>Weight</b>	10 g
<b>Connection type</b>	Male connector M8, 4-pin

### Ambient data

<b>Ambient operating temperature</b>	-40 °C ... +50 °C <sup>1)</sup>
<b>Ambient temperature, storage</b>	-40 °C ... +75 °C

<sup>1)</sup> As of  $T_a = 45$  °C, a max.load current  $I_{\max} = 50$  mA is permitted.

### Smart Task

<b>Smart Task name</b>	Base logics
<b>Logic function</b>	Direct AND OR WINDOW Hysteresis
<b>Timer function</b>	Deactivated Switch-on delay Off delay ON and OFF delay Impulse (one shot)
<b>Inverter</b>	Yes

Switching signal	
Switching signal Q <sub>L1</sub>	Switching output
Switching signal Q <sub>L2</sub>	Switching output

### Certificates

<b>EU declaration of conformity</b>	✓
<b>UK declaration of conformity</b>	✓
<b>ACMA declaration of conformity</b>	✓
<b>Moroccan declaration of conformity</b>	✓
<b>China-RoHS</b>	✓
<b>cULus certificate</b>	✓
<b>IO-Link</b>	✓
<b>Laser safety (IEC 60825-1) certificate</b>	✓

### Classifications

<b>ECLASS 5.0</b>	27270904
<b>ECLASS 5.1.4</b>	27270904
<b>ECLASS 6.0</b>	27270904
<b>ECLASS 6.2</b>	27270904
<b>ECLASS 7.0</b>	27270904
<b>ECLASS 8.0</b>	27270904
<b>ECLASS 8.1</b>	27270904
<b>ECLASS 9.0</b>	27270904
<b>ECLASS 10.0</b>	27270904
<b>ECLASS 11.0</b>	27270904
<b>ECLASS 12.0</b>	27270903
<b>ETIM 5.0</b>	EC002719
<b>ETIM 6.0</b>	EC002719
<b>ETIM 7.0</b>	EC002719
<b>ETIM 8.0</b>	EC002719
<b>UNSPSC 16.0901</b>	39121528

### Dimensional drawing

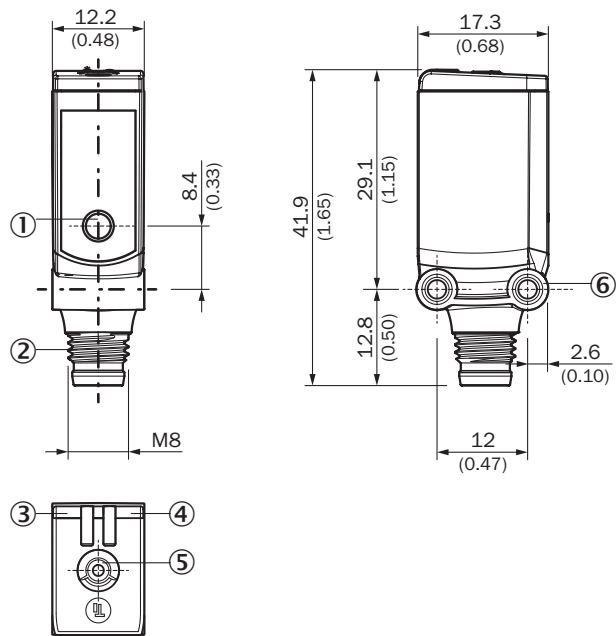

Dimensions in mm (inch)

- ① Center of optical axis
- ② Connection
- ③ LED indicator green: power
- ④ LED indicator yellow: Status of received light beam
- ⑤ single teach-in button
- ⑥ Threaded mounting hole M3

### Connection diagram Cd-450

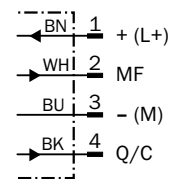

Default: MF = Test

### Light spot size

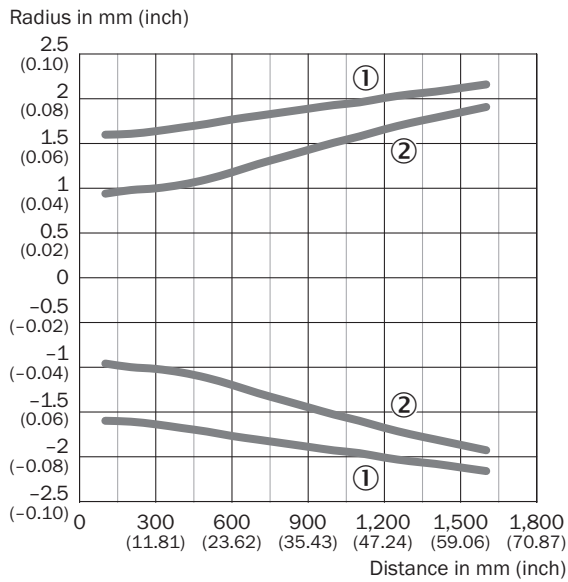

- ① Light spot horizontal
- ② Light spot vertical

### Scanning range

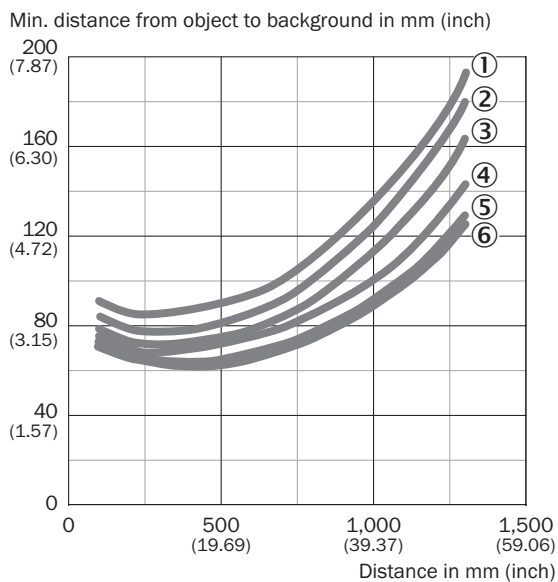

- ① 6 % / 90 % AVG1
- ② 6 % / 90 % AVG2
- ③ 6 % / 90 % AVG4
- ④ 6 % / 90 % AVG8
- ⑤ 6 % / 90 % AVG64
- ⑥ 6 % / 90 % AVG512

### Scanning range

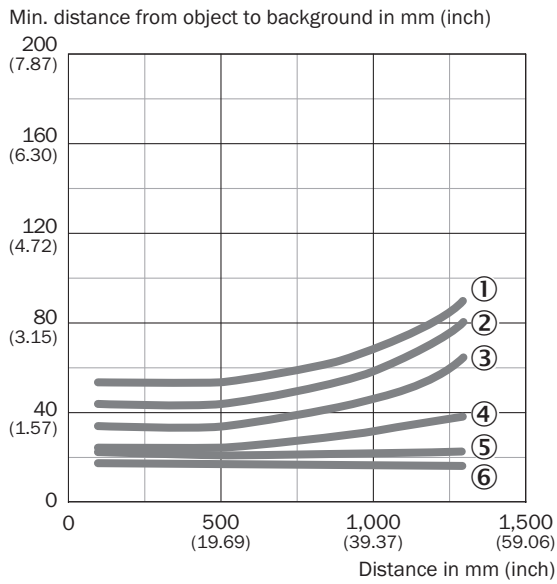

- ① 90 % / 90 % AVG1
- ② 90 % / 90 % AVG2
- ③ 90 % / 90 % AVG4
- ④ 90 % / 90 % AVG8
- ⑤ 90 % / 90 % AVG64
- ⑥ 90 % / 90 % AVG512

### Repeatability

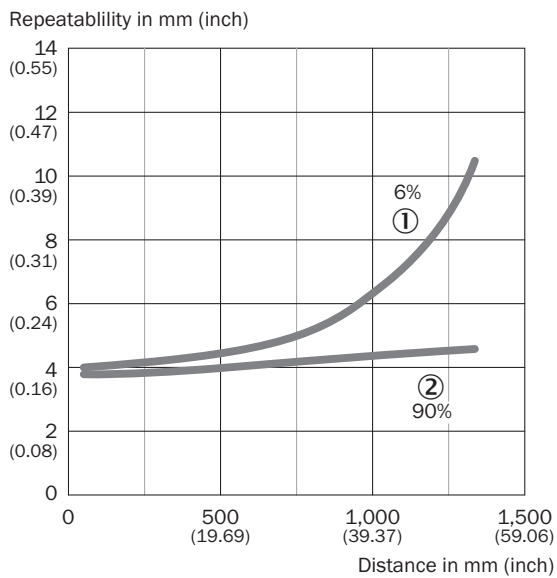

- ① 6 % remission, on black
- ② 90 % remission, on white



### Recommended accessories

Other models and accessories → [www.sick.com/WTT4\\_PowerProx](http://www.sick.com/WTT4_PowerProx)

	Brief description	Type	part no.
Mounting systems			
	<ul style="list-style-type: none"> <li><b>Description:</b> Plate N08N for universal clamp bracket</li> <li><b>Material:</b> Stainless steel, stainless steel</li> <li><b>Details:</b> Stainless steel 1.4571 (sheet), Stainless steel 1.4408 (clamp)</li> <li><b>Items supplied:</b> Universal clamp (5322627), mounting hardware</li> <li><b>Usable for:</b> W100, W150, W4-3, W4S-3, W8, W9-3, W8G, W8 Laser, W8 Inox, G6, W100 Laser, W100-2, W4-3 Glass, W4S-3 Glass, RAY10, W4SLG-3, W9, GR18, MultiPulse, Reflex Array, Multi-Line, LUT3, KT5, KT8, KT10, CS8, G6 Inox</li> </ul>	BEF-KHS-N08N	2051616

## SICK AT A GLANCE

SICK is one of the leading manufacturers of intelligent sensors and sensor solutions for industrial applications. A unique range of products and services creates the perfect basis for controlling processes securely and efficiently, protecting individuals from accidents and preventing damage to the environment.

We have extensive experience in a wide range of industries and understand their processes and requirements. With intelligent sensors, we can deliver exactly what our customers need. In application centers in Europe, Asia and North America, system solutions are tested and optimized in accordance with customer specifications. All this makes us a reliable supplier and development partner.

Comprehensive services complete our offering: SICK LifeTime Services provide support throughout the machine life cycle and ensure safety and productivity.

For us, that is “Sensor Intelligence.”

## WORLDWIDE PRESENCE:

Contacts and other locations –[www.sick.com](http://www.sick.com)